

SP 500 M - SP 500 M PLC

DESCRIZIONE
 Portata massima 500 kg.
 Inclinazione manuale.
 Rotazione con motore in corrente alternata, con inverter, riduttore a vite senza fine e ralla a sfere.
 Pedale (marcia-arresto) con cavo 5 m.
 * PLC Version con gestione: SP/TT, SP/SCH, SP/TF.

DESCRIPTION
 Maximum load 500 kg.
 Manual tilt.
 Slewing by AC motor with inverter through worm and wheel gearbox and ball slewing ring.
 Single pedal control (start-stop) and 5 m cable.
 * PLC Version for: SP/TT, SP/SCH, SP/TF.

BESCHREIBUNG
 Maximale Tragfähigkeit 500 kg.
 Kippung manuell.
 Rotation mit AC-Elektromotor und Inverter, Endlosschneckenuntersetzung und Kugelscheibe.
 Fusspedal mit Start-Stop-Funktion.
 * PLC Version mit Regelung: SP/TT, SP/SCH, SP/TF.

DESCRIPTION
 Portée max 500 kg.
 Inclinaison manuelle.
 Rotation avec moteur à courant alternée, avec inverter, réducteur à vis sans fin et butée à billes.
 Pédale marche/arret avec câble 5 m.
 * PLC Version automate avec gestion: SP/TT, SP/SCH, SP/TF.

DESCRIPCIÓN
 Capacidad máxima 500 kg.
 Inclinación manual.
 Rotación por motor de corriente alterna con inverter, reductor de tornillo sin fin y rangua de bolas.
 Pedal (marcha-parada) con cable 5 m.
 * PLC Version con gestion: SP/TT, SP/SCH, SP/TF.

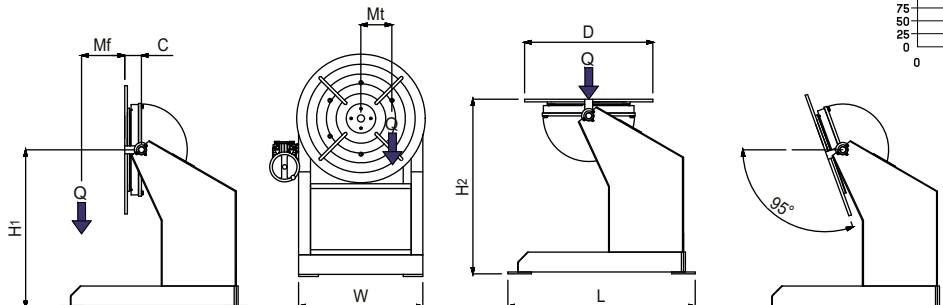
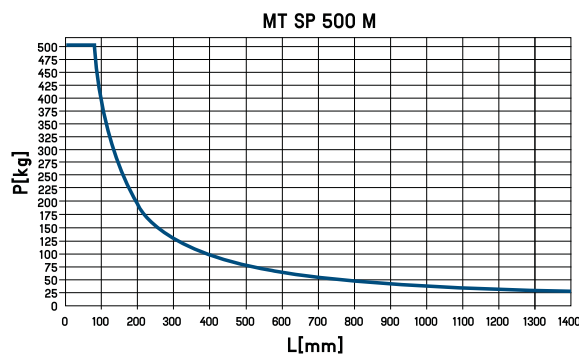
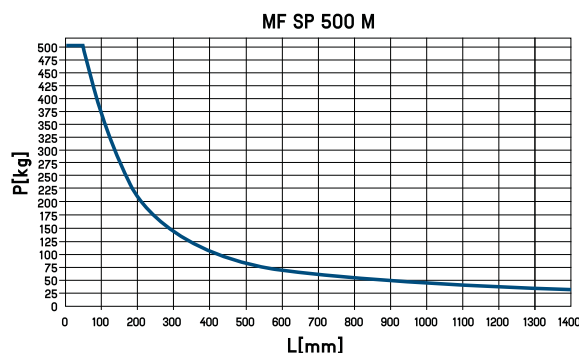

Q kg	MT danm	MF danm	D mm	H1 mm	H2 mm	C mm	L mm	W mm	rpm	sec	volt	volt	kg
500	40	64	650	750	835	85	800	650	0,3-3	50	1x230	24	230