

SPK

1500 - 3500 - 7000

Posizionatori a tavola rotante elevabili portata 1500 - 3500 - 7000 kg





3 axes positioners with 1500 - 3500 - 7000 kg capacity

3 Achsen mit Tragfaehigkeit 1500 - 3500 - 7000 kg

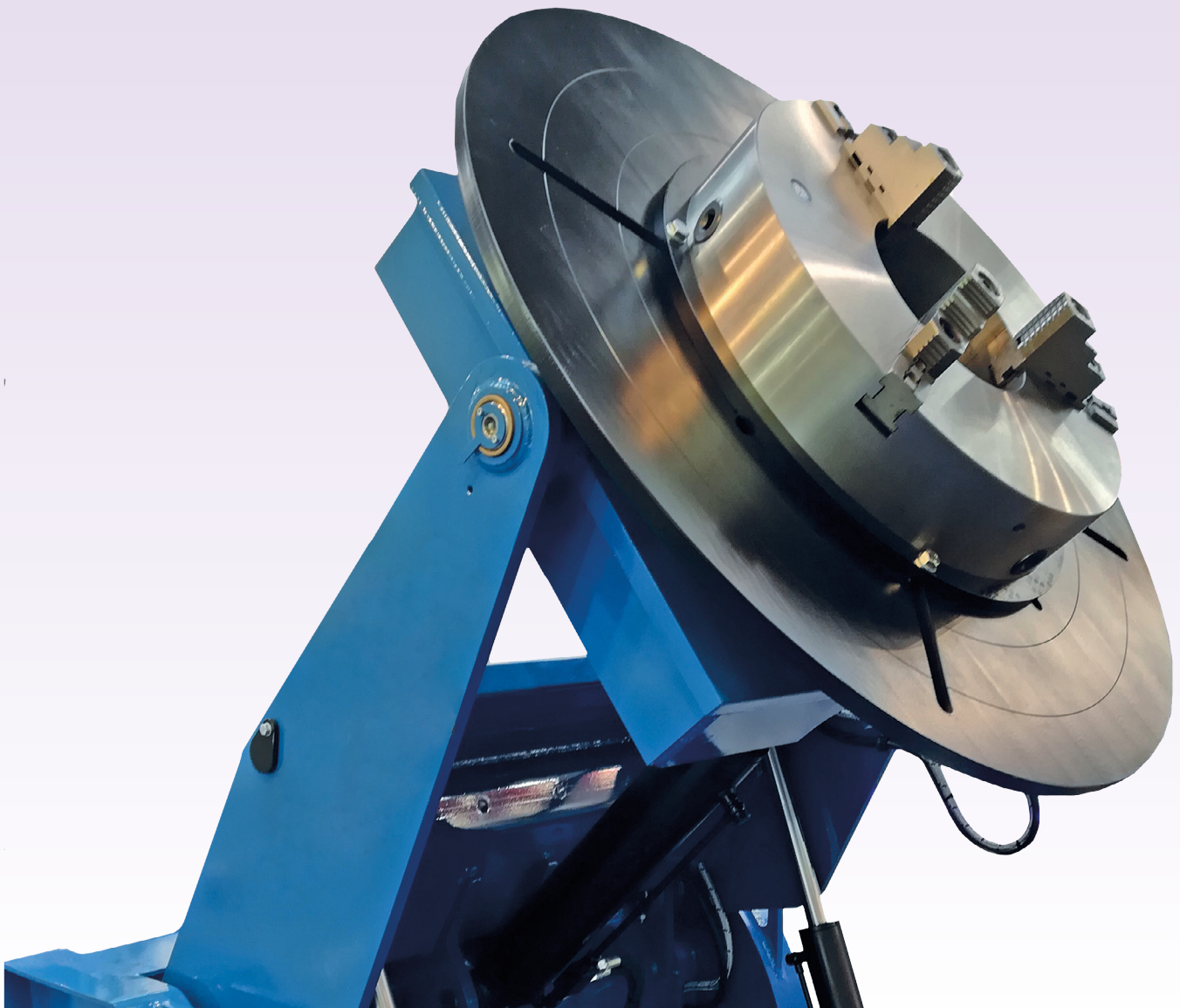
Positionneurs à 3 axes capacité de 1500 - 3500 - 7000 kg

Posicionadores de 3 ejes con capacidad de 1500 - 3500 - 7000 kg



-  Posizionatori a tavola rotante elevabile con portata 1500 - 3500 - 7000 kg.
3 assi di movimento.
Sollevamento ed inclinazione oleodinamica.
Rotazione con motore in corrente alternata, con inverter, riduttore a vite senza fine e ralla a sfere.
Pedale (marcia-arresto) con 5 m e pulsantiera marcia-arresto con cavo 5 m.
-  Elevating turntable positioners with 1500 - 3500 - 7000 kg capacity.
3 axes of movement.
Hydraulic lifting and tilting.
Rotation by AC motor, with inverter, worm gearbox and ball slewing ring.
Foot pedal (run-stop) with 5 m and run-stop push-button panel with 5 m cable.
-  Hub-Drehtisch-Positionierer mit einer Tragfähigkeit von 1500 - 3500 - 7000 kg.
3 Achsen der Bewegung.
Hydraulisches Heben und Kippen.
Drehung durch AC-Motor, mit Inverter, Schneckengetriebe und Kugellager.
Fußpedal (Run-Stop) mit 5 m und Run-Stop-Druckknopftafel mit 5 m Kabel.
-  Positionneurs à plateau tournant d'une capacité de 1500 - 3500 - 7000 kg.
3 axes de mouvement.
Levage et inclinaison hydrauliques.
Rotation par moteur à courant alternatif, avec inverseur, réducteur à vis sans fin et roulement à billes.
Pédale (arrêt de marche) avec 5 m et tableau de commande d'arrêt de marche avec câble 5 m.
-  Posicionadores giratorios elevables con una capacidad de 1500 - 3500 - 7000 kg.
3 ejes de movimiento.
Elevación e inclinación hidráulicas.
Rotación por motor de corriente alterna, con inversor, reductor de tornillo sin fin y rodamiento de bolas.
Pedal (marcha-paro) con 5 m y botonera de marcha-paro con cable de 5 m.

SPK 1500 - 3500 - 7000

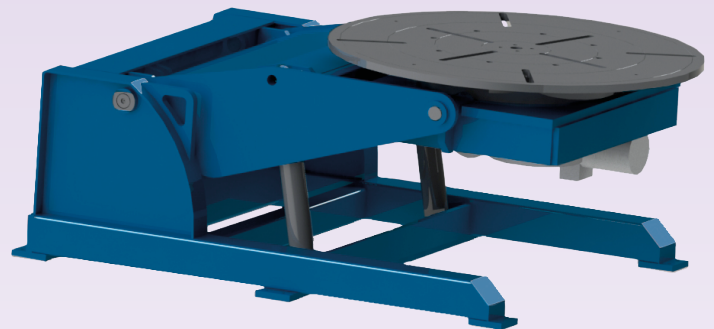
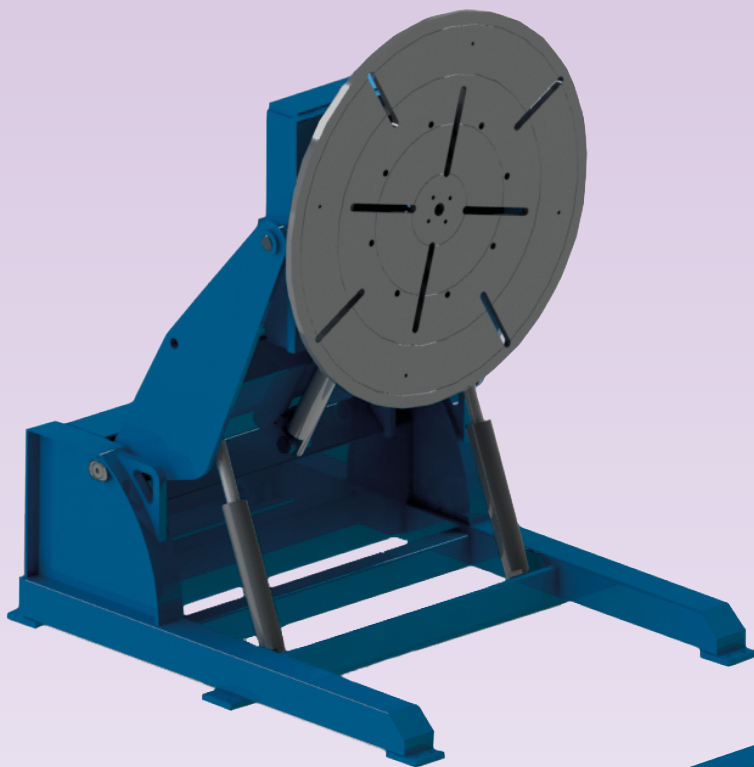

	SPK 1500	SPK 3500	SPK 7000
Q	1500 kg	3500 kg	7000 kg
A	620 mm	630 mm	840 mm
B	750 mm	760 mm	1017 mm
C	1450 mm	1470 mm	1677 mm
D	900 mm	1400 mm	1600 mm
E	1890 mm	1990 mm	2522 mm
F	1600 mm	1720 mm	2040 mm
H	1150 mm	1380 mm	1780 mm
L	1370 mm	1390 mm	1500 mm
MT	140 Nm	600 Nm	1150 Nm
MF	375 Nm	1100 Nm	2300 Nm
RPM	0,15-1,5	0,053-0,53	0,037-0,56
↑/↓ (sec)	35/23	54/38	98/86
Tilt 0-131 (sec)	55	74	63
Tilt 131-0 (sec)	42	56	70

SPK 1500 - 3500 - 7000

